

CUSTOMER TERMINAL	ROHS	Lead (Pb) -free
	YES	YES

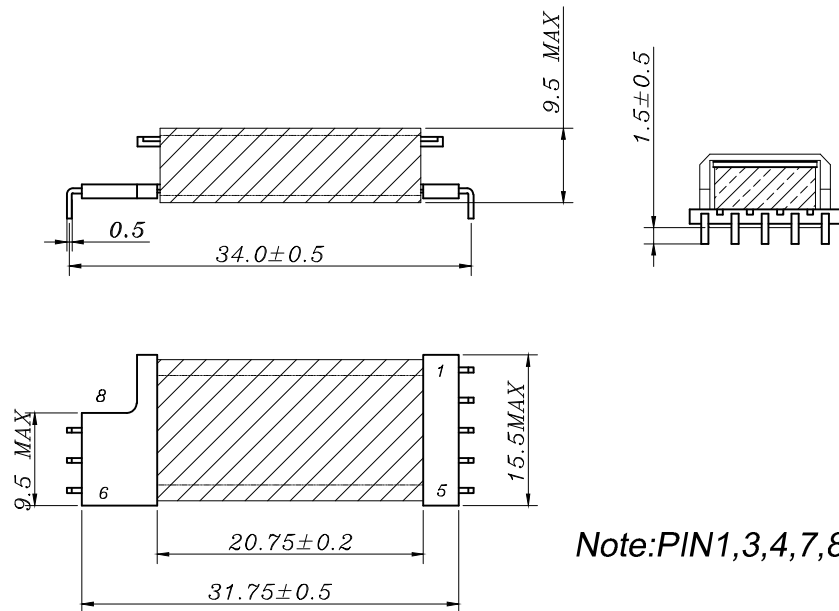

1. Mechanical Dimensions



Note: PIN1,3,4,7,8 cut off

2. Schematic Diagram

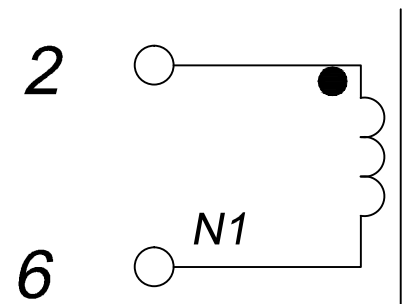

3. Material List

Core:FW40-EDR20
 Bobbin:FWB2009(5+3PIN)
 Wire:2UEW
 Glue:E-500(black) 130°C
 Operating Temperature: -30 to 115°C

4. Electrical Specification

Inductance: L (2-6) =470uH±5% 1KHZ 0.25V
 HI-POT: coil-core AC 2000V 1mA 5S

REV.	DATE	 Convention Placement	DRW.	Drawing Title: TRANSFORMER Customer P/N:	Part No:
0	00/00		CHK.		FWPTEDR20V471J
RoHS		www.ferriwo.com	APP.		Specification Sheet 1 of 1